

Features

- Epitaxial Planar Die Construction
- Complementary NPN Types Available (DDTC)
- Built-In Biasing Resistors, R1≠R2
- Lead Free/RoHS Compliant (Note 1)
- "Green" Device (Note 2 & 3)

Mechanical Data

- Case: SOT-323
- Case Material: Molded Plastic, "Green" Molding Compound, Note 3. UL Flammability Classification Rating 94V-0
- Moisture Sensitivity: Level 1 per J-STD-020C
- Terminal Connections: See Diagram
- Terminals: Solderable per MIL-STD-202, Method 208
- Lead Free Plating (Matte Tin Finish annealed over Alloy 42 leadframe).
- Marking Information: See Page 4
- Type Code: See Table Below
- Ordering Information: See Page 4
- Weight: 0.006 grams (approximate)



| SOT-323 | | |
|---------|--------------|------|
| Dim | Min | Max |
| A | 0.25 | 0.40 |
| B | 1.15 | 1.35 |
| C | 2.00 | 2.20 |
| D | 0.65 Nominal | |
| E | 0.30 | 0.40 |
| G | 1.20 | 1.40 |
| H | 1.80 | 2.20 |
| J | 0.0 | 0.10 |
| K | 0.90 | 1.00 |
| L | 0.25 | 0.40 |
| M | 0.10 | 0.18 |
| α | 0° | 8° |

All Dimensions in mm

| P/N | R1 (NOM) | R2 (NOM) | Type Code |
|------------|----------|----------|-----------|
| DDTA113ZUA | 1KΩ | 10KΩ | P02 |
| DDTA123YUA | 2.2KΩ | 10KΩ | P05 |
| DDTA123JUA | 2.2KΩ | 47KΩ | P06 |
| DDTA143XUA | 4.7KΩ | 10KΩ | P09 |
| DDTA143FUA | 4.7KΩ | 22KΩ | P10 |
| DDTA143ZUA | 4.7KΩ | 47KΩ | P11 |
| DDTA114YUA | 10KΩ | 47KΩ | P14 |
| DDTA114WUA | 10KΩ | 4.7KΩ | P15 |
| DDTA124XUA | 22KΩ | 47KΩ | P18 |
| DDTA144VUA | 47KΩ | 10KΩ | P21 |
| DDTA144WUA | 47KΩ | 22KΩ | P22 |

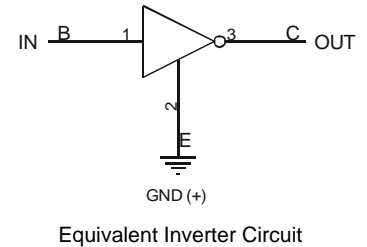
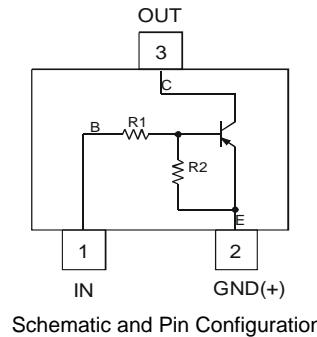

Maximum Ratings @T_A = 25°C unless otherwise specified

| Characteristic | Symbol | Value | Unit |
|----------------------------|-----------------|---|------|
| Supply Voltage, (3) to (2) | V _{CC} | -50 | V |
| Input Voltage, (1) to (2) | V _{IN} | +5 to -10 +5 to -12 +5 to -12 +7 to -20 +6 to -30 +5 to -30 +6 to -40 +10 to -30 +10 to -40 +15 to -40 +10 to -40 | V |
| Output Current | I _O | -100 -100 -100 -100 -100 -100 -70 -100 -50 -30 -30 | mA |

- Notes:
1. No purposefully added lead.
 2. Diodes Inc.'s "Green" policy can be found on our website at http://www.diodes.com/products/lead_free/index.php.
 3. Product manufactured with Date Code 0627 (week 27, 2006) and newer are built with Green Molding Compound. Product manufactured prior to Date Code 0627 are built with Non-Green Molding Compound and may contain Halogens or Sb2O3 Fire Retardants.

Maximum Ratings (continued) @T_A = 25°C unless otherwise specified

| Characteristic | Symbol | Value | Unit |
|--|-----------------------------------|-------------|------|
| Output Current | I _C (Max) | -100 | mA |
| Power Dissipation | P _d | 200 | mW |
| Thermal Resistance, Junction to Ambient Air (Note 4) | R _{θJA} | 625 | °C/W |
| Operating and Storage Temperature Range | T _j , T _{STG} | -55 to +150 | °C |

Notes: 4. Mounted on FR4 PC Board with recommended pad layout as shown on Diodes Inc., suggested pad layout document AP02001, which can be found on our website at <http://www.diodes.com/datasheets/ap02001.pdf>

Electrical Characteristics @T_A = 25°C unless otherwise specified

| Characteristic | Symbol | Min | Typ | Max | Unit | Test Condition | | | |
|----------------------------|---------------------------------|------------|------|-------|------|---|--|--|--|
| Input Voltage | V _{I(off)} | -0.3 | | | V | V _{CC} = 5V, I _O = 100μA | | | |
| | | -0.3 | | | | | | | |
| | | -0.5 | | | | | | | |
| | | -0.3 | | | | | | | |
| | | -0.3 | | | | | | | |
| | | -0.5 | — | — | | | | | |
| | | -0.3 | | | | | | | |
| | | -0.8 | | | | | | | |
| | | -0.4 | | | | | | | |
| | | -1.0 | | | | | | | |
| | | -0.8 | | | | | | | |
| | | DDTA113ZUA | | | | | | | |
| | | DDTA123YUA | | | | | | | |
| | | DDTA123JUA | | | | | | | |
| DDTA143XUA | | | | | | | | | |
| DDTA143FUA | | | | | | | | | |
| DDTA143ZUA | | | | | | | | | |
| DDTA114YUA | | | | | | | | | |
| DDTA114WUA | | | | | | | | | |
| DDTA124XUA | | | | | | | | | |
| DDTA144VUA | | | | | | | | | |
| DDTA144WUA | | | | | | | | | |
| Input Voltage | V _{I(on)} | | | -3.0 | V | V _O = -0.3V, I _O = -20mA V _O = -0.3V, I _O = -20mA V _O = -0.3V, I _O = -5mA V _O = -0.3V, I _O = -20mA V _O = -0.3V, I _O = -3mA V _O = -0.3V, I _O = -5mA V _O = -0.3V, I _O = -1mA V _O = -0.3V, I _O = -2mA V _O = -0.3V, I _O = -2mA V _O = -0.3V, I _O = -2mA V _O = -0.3V, I _O = -2mA V _O = -0.3V, I _O = -2mA | | | |
| | | | | -3.0 | | | | | |
| | | | | -1.1 | | | | | |
| | | | | -2.5 | | | | | |
| | | | | -1.3 | | | | | |
| | | | | -1.3 | | | | | |
| | | | | -1.4 | | | | | |
| | | | | -3.0 | | | | | |
| | | | | -2.5 | | | | | |
| | | | | -5.0 | | | | | |
| | | | | -4.0 | | | | | |
| | | DDTA113ZUA | | | | | | | |
| | | DDTA123YUA | | | | | | | |
| | | DDTA123JUA | | | | | | | |
| DDTA143XUA | | | | | | | | | |
| DDTA143FUA | | | | | | | | | |
| DDTA143ZUA | | | | | | | | | |
| DDTA114YUA | | | | | | | | | |
| DDTA114WUA | | | | | | | | | |
| DDTA124XUA | | | | | | | | | |
| DDTA144VUA | | | | | | | | | |
| DDTA144WUA | | | | | | | | | |
| Output Voltage | V _{O(on)} | — | -0.1 | -0.3 | V | I _O /I _I = -5mA/-0.25mA DDTA123JUA I _O /I _I = -5mA/-0.25mA DDTA143ZUA I _O /I _I = -5mA/-0.25mA DDTA114YUA I _O /I _I = -10mA/-0.5mA All Others | | | |
| Input Current | I _I | | | -7.2 | mA | V _I = -5V | | | |
| | | | | -3.8 | | | | | |
| | | | | -3.6 | | | | | |
| | | | | -1.8 | | | | | |
| | | | | -1.8 | | | | | |
| | | | | -1.8 | | | | | |
| | | | | -0.88 | | | | | |
| | | | | -0.88 | | | | | |
| | | | | -0.36 | | | | | |
| | | | | -0.16 | | | | | |
| | | | | -0.16 | | | | | |
| | | DDTA113ZUA | | | | | | | |
| | | DDTA123YUA | | | | | | | |
| | | DDTA123JUA | | | | | | | |
| DDTA143XUA | | | | | | | | | |
| DDTA143FUA | | | | | | | | | |
| DDTA143ZUA | | | | | | | | | |
| DDTA114YUA | | | | | | | | | |
| DDTA114WUA | | | | | | | | | |
| DDTA124XUA | | | | | | | | | |
| DDTA144VUA | | | | | | | | | |
| DDTA144WUA | | | | | | | | | |
| Output Current | I _{O(off)} | — | — | -0.5 | μA | V _{CC} = -50V, V _I = 0V | | | |
| DC Current Gain | G _I | -33 | | | — | V _O = -5V, I _O = -10mA | | | |
| | | -33 | | | | | | | |
| | | -80 | | | | | | | |
| | | -30 | | | | | | | |
| | | -68 | | | | | | | |
| | | -80 | | | | | | | |
| | | -68 | | | | | | | |
| | | -24 | | | | | | | |
| | | -68 | | | | | | | |
| | | -33 | | | | | | | |
| | | -56 | | | | | | | |
| | | DDTA113ZUA | | | | | | | |
| | | DDTA123YUA | | | | | | | |
| | | DDTA123JUA | | | | | | | |
| DDTA143XUA | | | | | | | | | |
| DDTA143FUA | | | | | | | | | |
| DDTA143ZUA | | | | | | | | | |
| DDTA114YUA | | | | | | | | | |
| DDTA114WUA | | | | | | | | | |
| DDTA124XUA | | | | | | | | | |
| DDTA144VUA | | | | | | | | | |
| DDTA144WUA | | | | | | | | | |
| Input Resistor Tolerance | ΔR ₁ | -30 | — | +30 | % | — | | | |
| Resistance Ratio Tolerance | ΔR ₂ /R ₁ | -20 | — | +20 | % | — | | | |
| Gain-Bandwidth Product* | f _T | — | 250 | — | MHz | V _{CE} = -10V, I _E = 5mA, f = 100MHz | | | |

* Transistor - For Reference Only

Typical Curves – DDTA123JUA

NEW PRODUCT



Fig. 1 Derating Curve

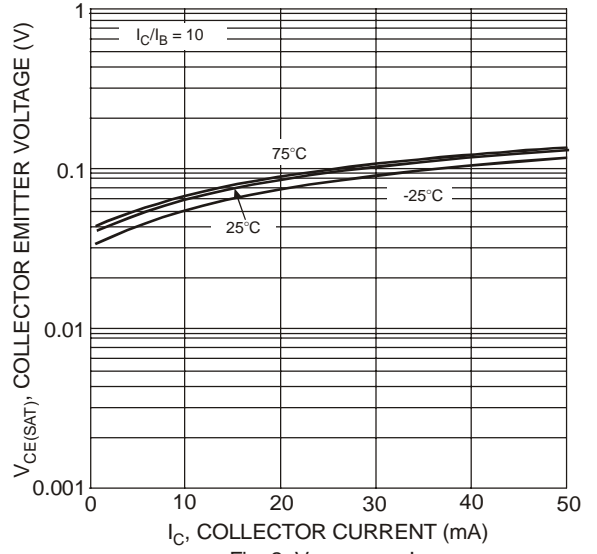

Fig. 2 $V_{CE(SAT)}$ vs. I_C

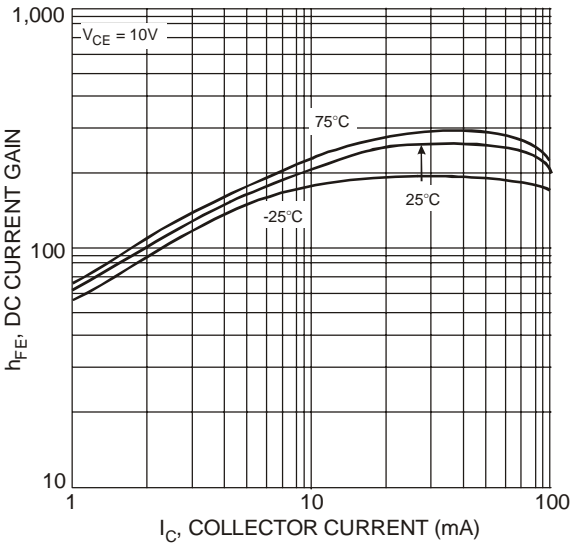

Fig. 3 DC Current Gain

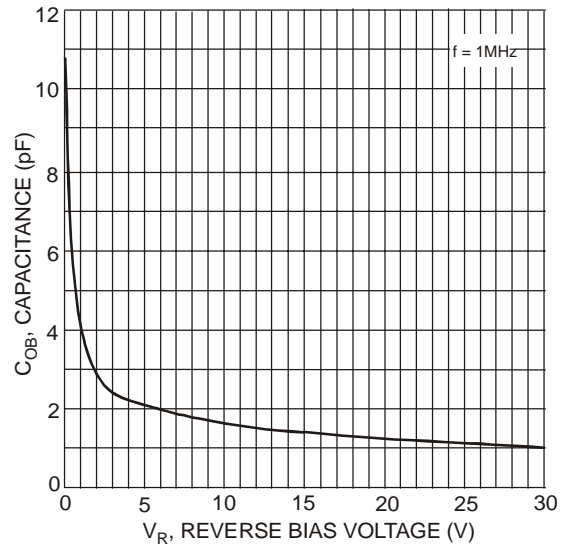

Fig. 4 Output Capacitance

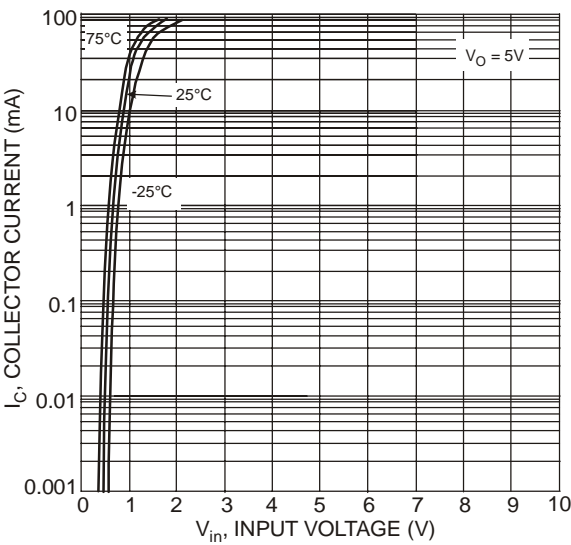

Fig. 5 Collector Current vs. Input Voltage

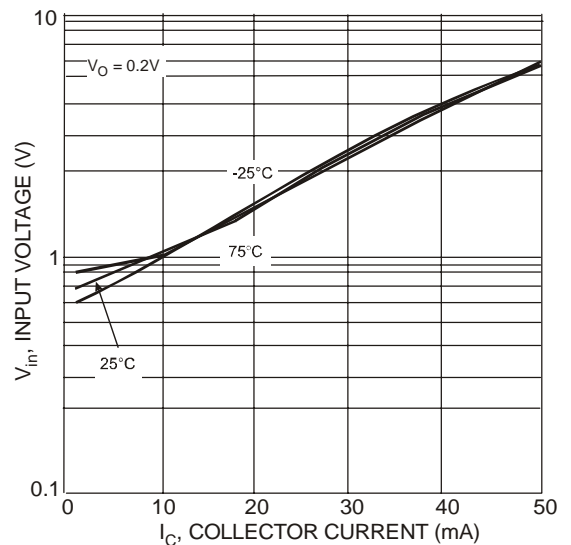

Fig. 6 Input Voltage vs. Collector Current

Ordering Information (Note 3 & 5)

| Device | Packaging | Shipping |
|----------------|-----------|------------------|
| DDTA113ZUA-7-F | SOT-323 | 3000/Tape & Reel |
| DDTA123YUA-7-F | SOT-323 | 3000/Tape & Reel |
| DDTA123JUA-7-F | SOT-323 | 3000/Tape & Reel |
| DDTA143XUA-7-F | SOT-323 | 3000/Tape & Reel |
| DDTA143FUA-7-F | SOT-323 | 3000/Tape & Reel |
| DDTA143ZUA-7-F | SOT-323 | 3000/Tape & Reel |
| DDTA114YUA-7-F | SOT-323 | 3000/Tape & Reel |
| DDTA114WUA-7-F | SOT-323 | 3000/Tape & Reel |
| DDTA124XUA-7-F | SOT-323 | 3000/Tape & Reel |
| DDTA144VUA-7-F | SOT-323 | 3000/Tape & Reel |
| DDTA144WUA-7-F | SOT-323 | 3000/Tape & Reel |

Notes: 5. For packaging details, go to our website at <http://www.diodes.com/datasheets/ap02007.pdf>.

Marking Information

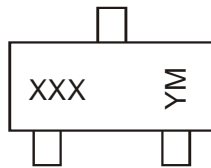

XXX = Product Type Marking Code, See Table on Page 1
 YM = Date Code Marking
 Y = Year ex: T = 2006
 M = Month ex: 9 = September

Date Code Key

| Year | 2006 | 2007 | 2008 | 2009 | 2010 | 2011 | 2012 |
|------|------|------|------|------|------|------|------|
| Code | T | U | V | W | X | Y | Z |

| Month | Jan | Feb | Mar | Apr | May | Jun | Jul | Aug | Sep | Oct | Nov | Dec |
|-------|-----|-----|-----|-----|-----|-----|-----|-----|-----|-----|-----|-----|
| Code | 1 | 2 | 3 | 4 | 5 | 6 | 7 | 8 | 9 | O | N | D |

IMPORTANT NOTICE

Diodes Incorporated and its subsidiaries reserve the right to make modifications, enhancements, improvements, corrections or other changes without further notice to any product herein. Diodes Incorporated does not assume any liability arising out of the application or use of any product described herein; neither does it convey any license under its patent rights, nor the rights of others. The user of products in such applications shall assume all risks of such use and will agree to hold Diodes Incorporated and all the companies whose products are represented on our website, harmless against all damages.

LIFE SUPPORT

Diodes Incorporated products are not authorized for use as critical components in life support devices or systems without the expressed written approval of the President of Diodes Incorporated.